



**Frames**  
By Riyom Global Solutions  
System Aluminium & uPVC Windows

 Frames

**Aluminium  
System Doors & Windows**

## ABOUT FRAMES

A better home is composed of precisely engineered components — high-performance doors and windows that enhance connectivity with the external environment, alongside thoughtfully designed interiors and exteriors that optimize spatial functionality and aesthetics. Recognized as the growing force, FRAMES delivers a comprehensive range of window and door solutions, combining exclusive designs with years of experience in delivering high-quality, innovative products tailored to meet diverse architectural and functional needs. Rooted in a commitment to excellence and inspired by the natural environment, FRAMES blends cutting-edge technology with thoughtful design to create solutions that connect people with the outdoors while ensuring energy efficiency and durability. Our portfolio features exclusive designs that cater to diverse architectural styles and evolving consumer needs.

At FRAMES, we believe that better living begins with simple, smart choices. We strive to build not just structures, but communities — fostering harmony between modern living and the environment for generations to come. Founded in 2019, FRAMES is an emerging brand redefining how people experience space — through innovative, sustainable, and design-driven window and door solutions. Headquartered in Indore, India, if you'd like to include it, we serve a growing global network of clients who value quality, aesthetics, and environmental responsibility.



FRAMES is a forward-thinking brand of high-performance aluminium and uPVC window systems, offering end-to-end glass solutions for residential, commercial, and institutional projects across global markets. With a strong focus on innovation, quality, and sustainability, we deliver comprehensive fenestration systems that combine advanced engineering with modern aesthetics. From concept to installation, FRAMES offers fully integrated solutions — including precision manufacturing and customized glass fittings — designed to meet the demands of today's evolving built environment.

## CORPORATE OVERVIEW

### Bringing Better Living Within Reach – For Everyone, Everywhere -Riyom Global Solutions

At FRAMES, we believe that everyone deserves access to a better life through smarter spaces and innovative living solutions. Established with a bold vision and built on strong foundations, we bring together years of expertise in housing, infrastructure, and sustainable development to create meaningful change in homes and communities around the world.

Inspired by excellence and guided by a global outlook, we design and deliver high-quality, forward-thinking products and services that improve everyday living. From the cities we help build to the lives we touch, our solutions reflect a commitment to quality, innovation, and environmental responsibility.

Through trusted partnerships and a diverse portfolio, FRAMES is impacting the way people live, one project at a time. And while we're proud of the progress we've made, we know the best is yet to come.

# #OurFactory



dedicated to delivering reliable window and door solutions that combine strength, style, and performance. Each product is carefully manufactured to meet high standards of quality and finish. Along with installation, we offer ongoing maintenance and support, ensuring long-term satisfaction and hassle-free usage for our customers.



## Casement Window

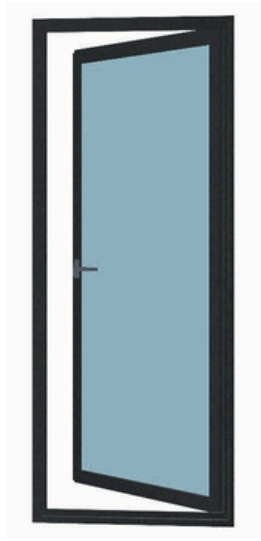

### TECHNICAL INFORMATION

- Frame Construction Depth: 40mm
- Locking System: Single Point
- Glass Range: 6mm to 24mm
- Corner Details: 45 degree cut, joint with corner connector
- Sealing Overlap: 6mm (Sealing with Gasket)
- Window Height (Max.): 1500mm
- Window Width (Max.): 600mm
- Finishes: Powder/Wood/Anodizing
- Alloy: 6063 T6

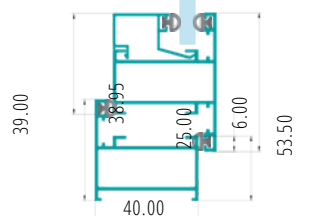
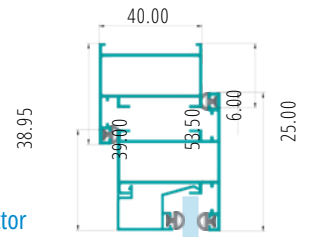
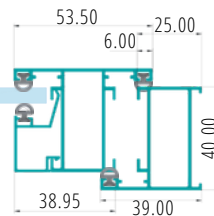
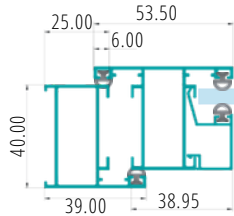

## Casement Door



### TECHNICAL INFORMATION

- Frame Construction Depth: 40mm
- Locking System: Single Point
- Glass Range: 6mm to 24mm
- Corner Details: 45 degree cut, joint with corner connector
- Sealing Overlap: 6mm (Sealing with Gasket)
- Door Height (Max.): 2130mm
- Door Width (Max.): 750mm
- Finishes: Powder/Wood/Anodizing
- Alloy: 6063 T6

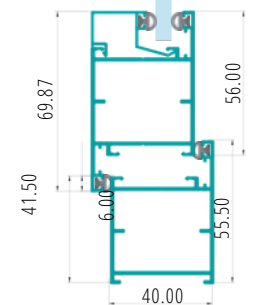
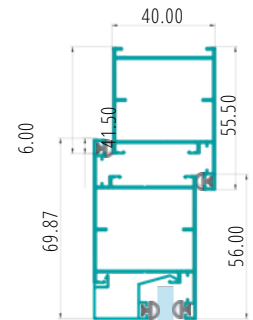
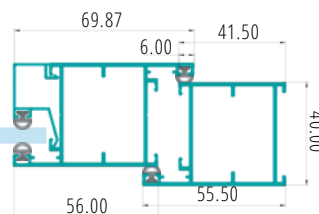
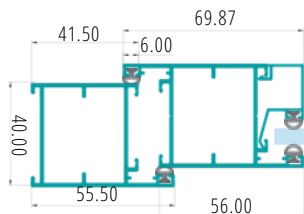

## Two Track Sliding Window



### TECHNICAL INFORMATION

- Frame Construction Depth: 46mm, Two Track
- Locking System: Single Point/Multipoint
- Glass Range: 6mm to 20mm
- Frame Corner Details: 45 degree cut, joint with screw
- Sash Corner Details: 45 degree cut, joint with corner connector
- Sealing Overlap: 8mm (Sealing with Brush Seal)
- Frame Height (Max.): 2440mm
- Sash Width (Max.): 1200mm
- Finishes: Powder/Wood/Anodizing
- Alloy: 6063 T6

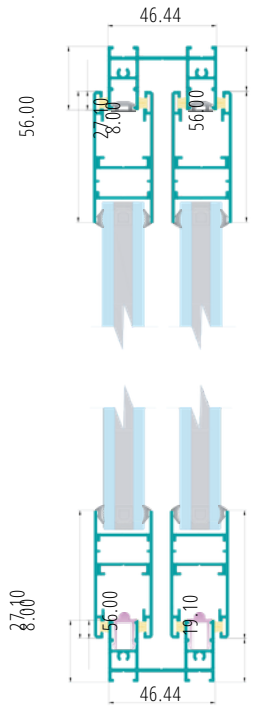
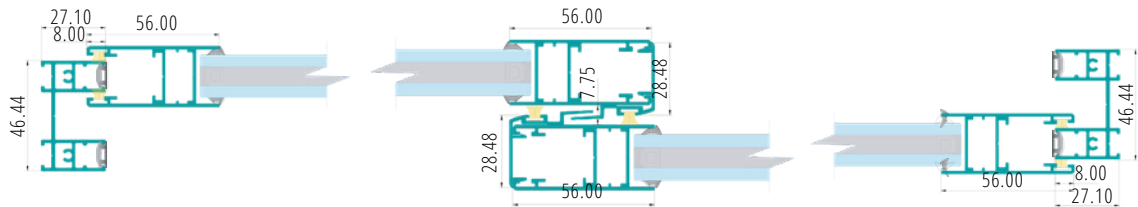

## Three Track Sliding Window



### TECHNICAL INFORMATION

- Frame Construction Depth: 80mm, Three Track
- Locking System: Single Point/Multipoint
- Glass Range: 6mm to 20mm
- Frame Corner Details: 45 degree cut, joint with screw
- Sash Corner Details: 45 degree cut, joint with corner connector
- Sealing Overlap: 8mm (Sealing with Brush Seal)
- Frame Height (Max.): 2440mm
- Sash Width (Max.): 1200mm
- Finishes: Powder/Wood/Anodizing
- Alloy: 6063 T6

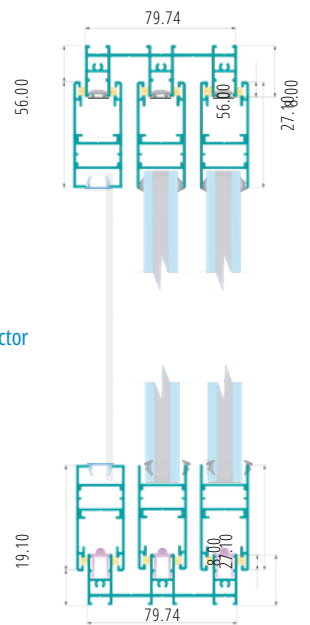
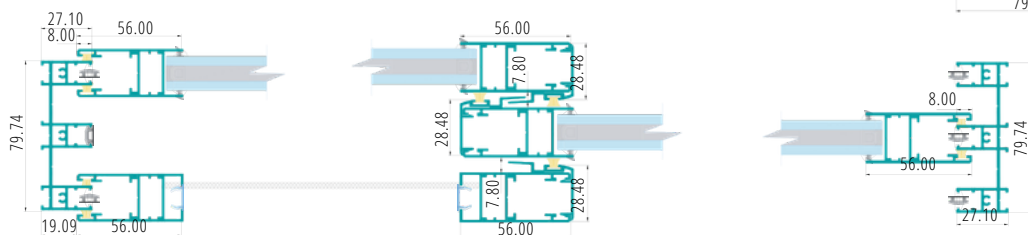

## Casement French Window



### TECHNICAL INFORMATION

- Frame Construction Depth: 50mm
- Locking System: Single Point/Multipoint
- Glass Range: 6mm to 32mm
- Corner Details: 45 degree cut, joint with corner connector
- Sealing Overlap: 6mm (Sealing with Gasket)
- Window Height (Max.): 2100mm
- Window Width (Max.): 800mm
- Finishes: Powder/Wood/Anodizing
- Alloy: 6063 T6

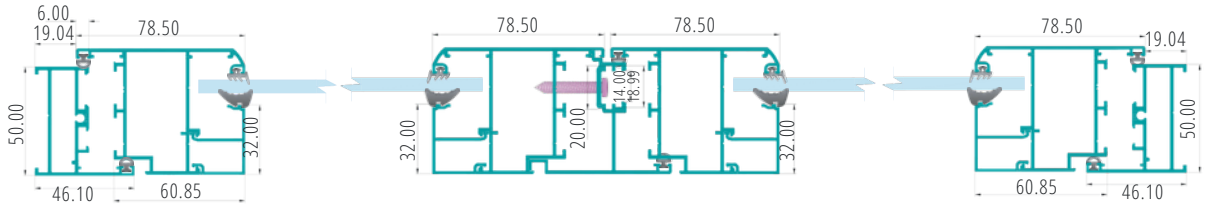

## Casement French Door



### TECHNICAL INFORMATION

- Frame Construction Depth: 50mm
- Locking System: Single Point/Multipoint
- Glass Range: 6mm to 32mm
- Corner Details: 45 degree cut, joint with corner connector
- Sealing Overlap: 6mm (Sealing with Gasket)
- Door Height (Max.): 2900mm
- Door Width (Max.): 900mm
- Finishes: Powder/Wood/Anodizing
- Alloy: 6063 T6

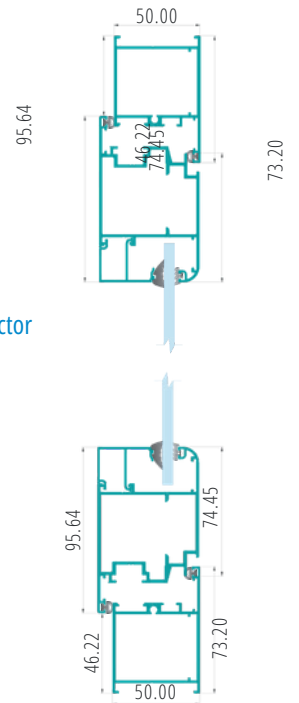
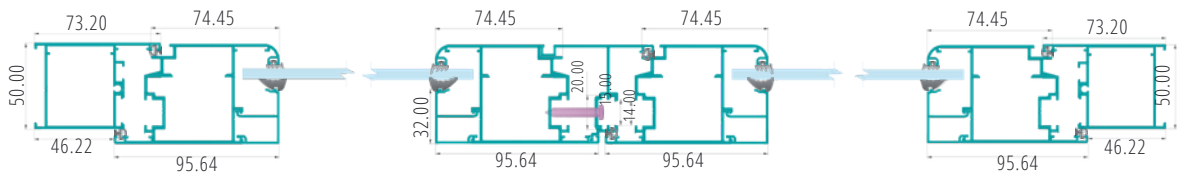

# PREMIUM VILLA SERIES



## TECHNICAL INFORMATION

- Frame Construction Depth: 50mm
- Locking System: Multipoint
- Glass Range: 6mm to 32mm
- Corner Details: 45 degree cut, joint with corner connector
- Sealing Overlap: 6mm (Sealing with Gasket)
- Window Height (Max.): 2400mm
- Window Width (Max.): 1220mm
- Finishes: Powder/Wood/Anodizing
- Alloy: 6063 T6

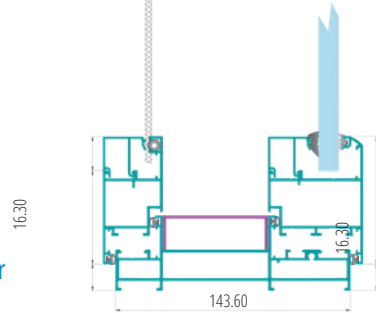
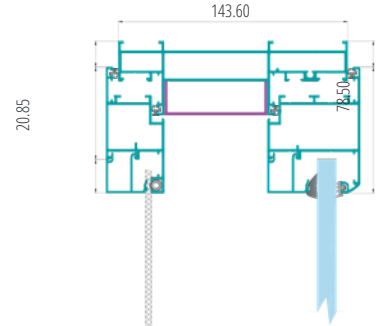

# PREMIUM SLIDING SERIES-29mm

## Two Track Sliding Window



### TECHNICAL INFORMATION

- Frame Construction Depth: 74mm, Two Track
- Locking System: Single Point/Multipoint
- Glass Range: 6mm to 22mm
- Slim Interlock: 24mm
- Corner Details: 45 degree cut, joint with corner connector
- Sealing Overlap: 8mm (Sealing with Brush Seal)
- Sash Height (Max.): 2900mm
- Sash Width (Max.): 1350mm
- Finishes: Powder/Wood/Anodizing
- Alloy: 6063 T6

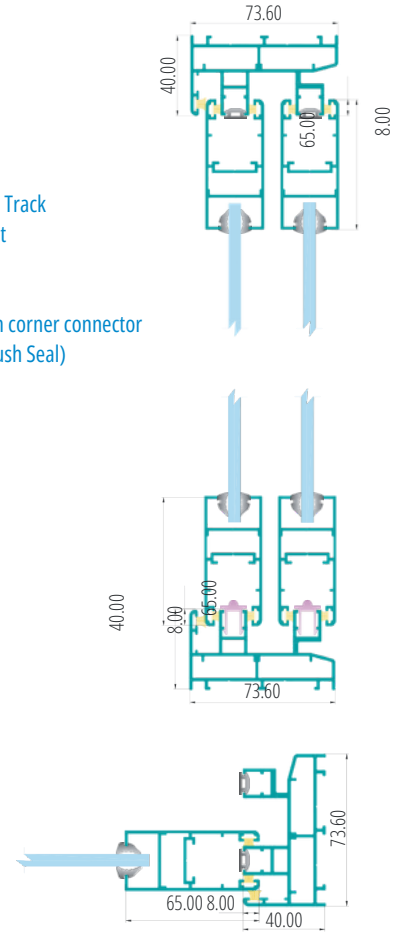
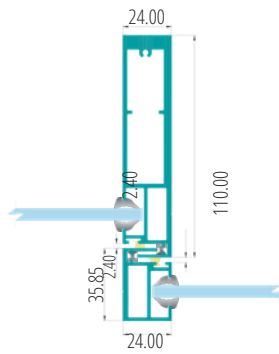
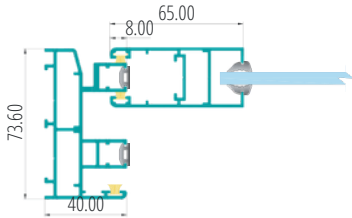

## Three Track Sliding Door



### TECHNICAL INFORMATION

- Frame Construction Depth: 112mm, Three Track
- Locking System: Single Point/Multipoint
- Glass Range: 6mm to 22mm
- Slim Interlock: 24mm
- Corner Details: 45 degree cut, joint with corner connector
- Sealing Overlap: 8mm (Sealing with Brush Seal)
- Sash Height (Max.): 2900mm
- Sash Width (Max.): 1350mm
- Finishes: Powder/Wood/Anodizing
- Alloy: 6063 T6

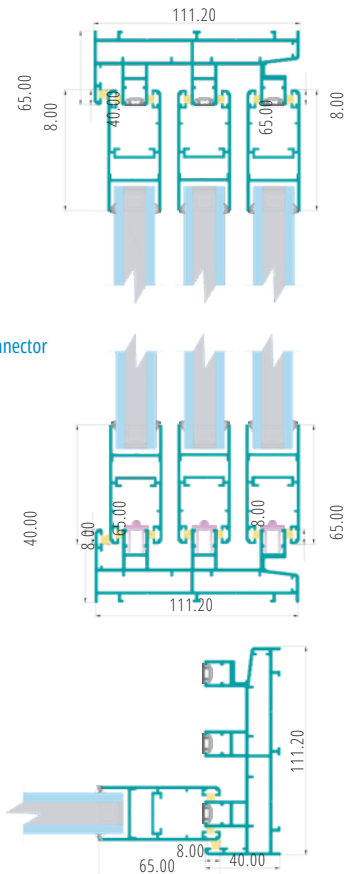
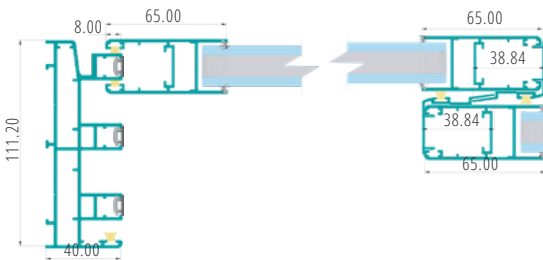

## Casement French Window



### TECHNICAL INFORMATION

- Frame Construction Depth: 60mm
- Locking System: Single Point/Multipoint
- Glass Range: 6mm to 32mm
- Corner Details: 45 degree cut, joint with corner connector
- Sealing Overlap: 6mm (Sealing with Gasket)
- Window Height (Max.): 2400mm
- Window Width (Max.): 900mm
- Finishes: Powder/Wood/Anodizing
- Alloy: 6063 T6

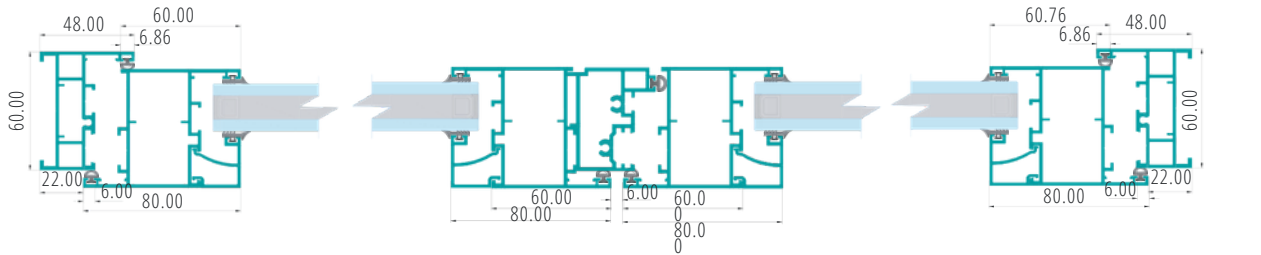

## Casement Door



### TECHNICAL INFORMATION

- Frame Construction Depth: 60mm
- Locking System: Single Point/Multipoint
- Glass Range: 6mm to 32mm
- Corner Details: 45 degree cut, joint with corner connector
- Sealing Overlap: 6mm (Sealing with Gasket)
- Door Height (Max.): 3500mm
- Door Width (Max.): 900mm
- Finishes: Powder/Wood/Anodizing
- Alloy: 6063 T6

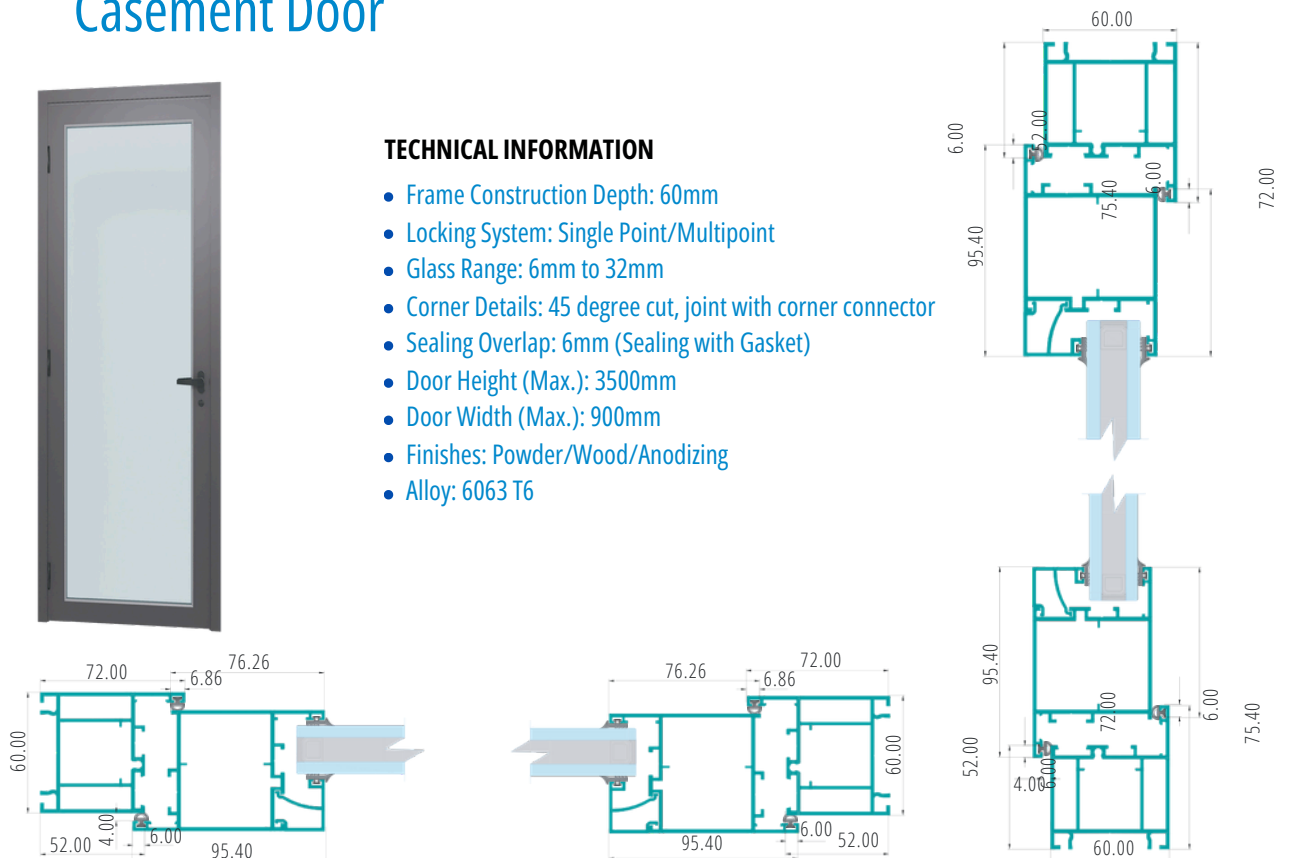

# SKY CASEMENT SERIES-60mm

## Tilt & Turn Window

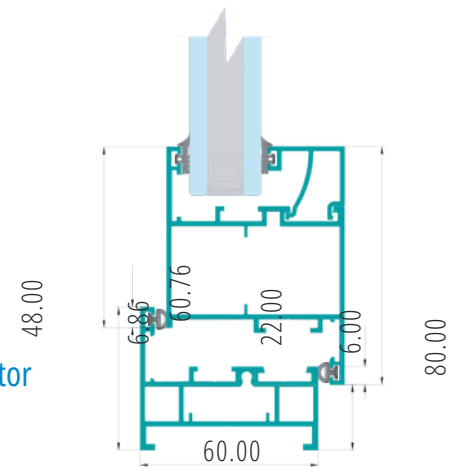
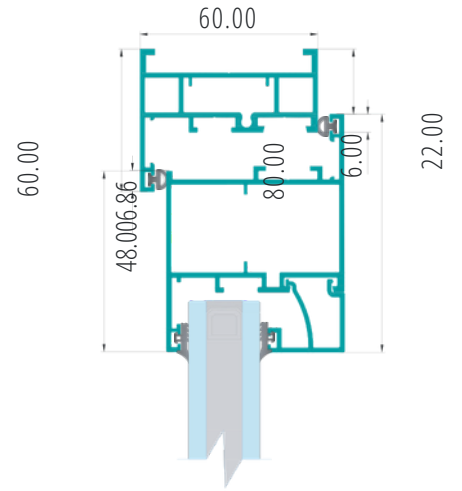

### TECHNICAL INFORMATION

- Frame Construction Depth: 60mm
- Locking System: Multipoint
- Glass Range: 6mm to 32mm
- Corner Details: 45 degree cut, joint with corner connector
- Sealing Overlap: 6mm (Sealing with Gasket)
- Window Height (Max.): 2400mm
- Window Width (Max.): 900mm
- Finishes: Powder/Wood/Anodizing
- Alloy: 6063 T6
- Hardware: GU/SIEGENIA

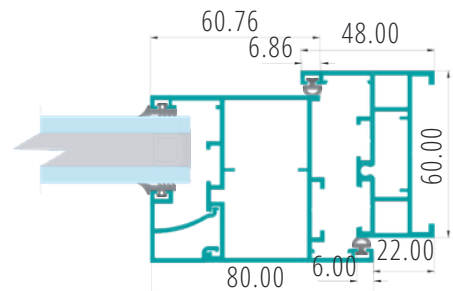
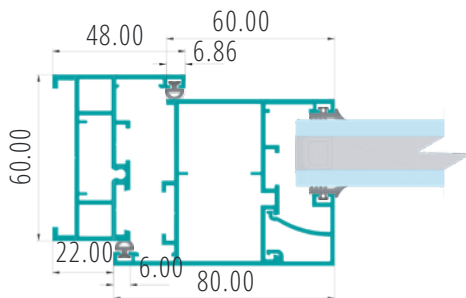



# SLIDE & FOLD

## POSSIBILITIES

### Design Scheme

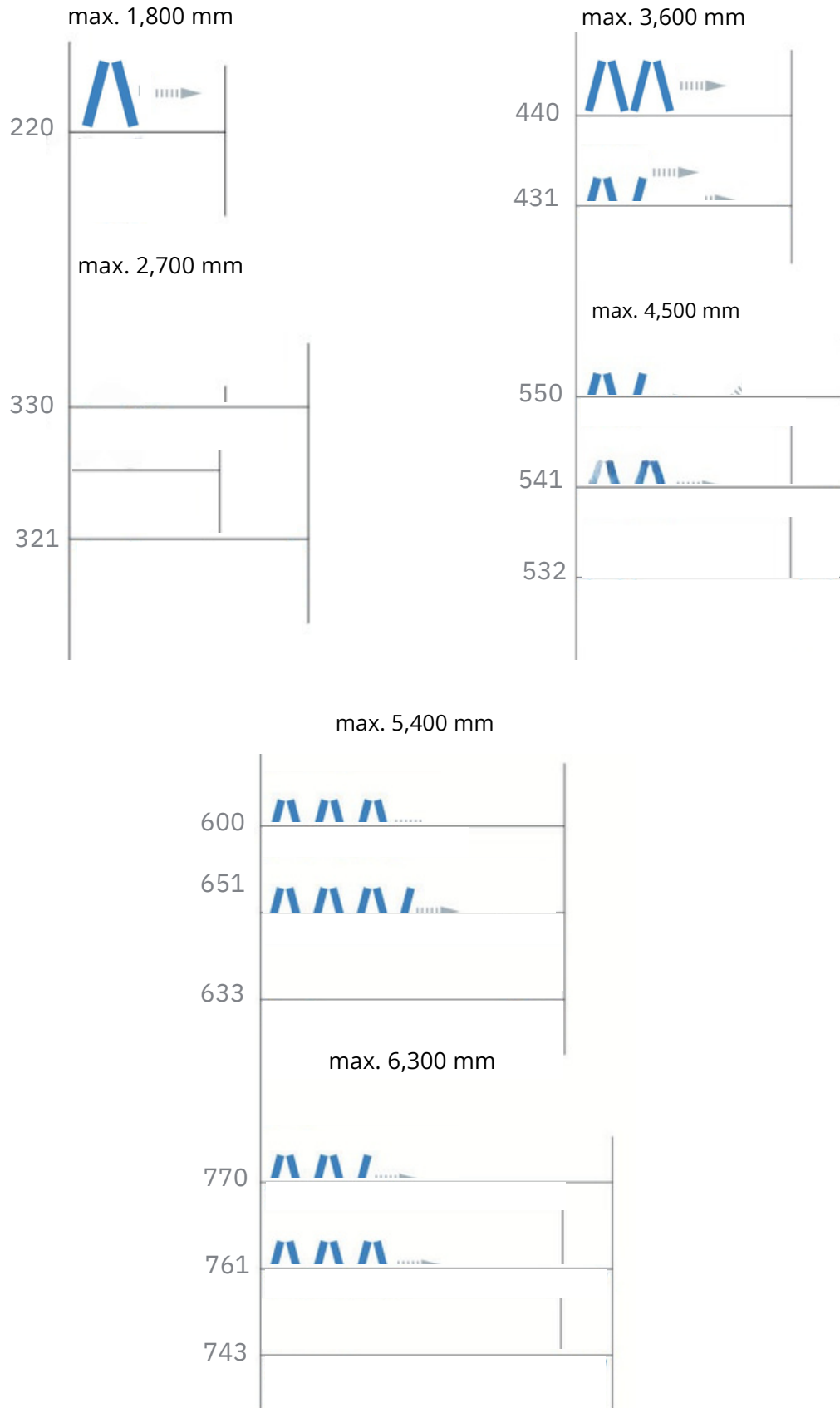

SKY SLIDING SERIES-41mm<sup>67.70</sup>

## Two Track Center Opening Sliding Door



### TECHNICAL INFORMATION

- Frame Construction Depth: 68mm, Two Track
- Locking System: Multipoint Cylinder Locking
- Glass Range: 6mm to 28mm
- Slim Interlock: 24mm
- Corner Details: 45 degree cut, joint with corner connector
- Sealing Overlap: 8mm (Sealing with Brush Seal)
- Sash Height (Max.): 3600mm
- Sash Width (Max.): 1600mm
- Finishes: Powder/Wood/Anodizing
- Alloy: 6063 T6

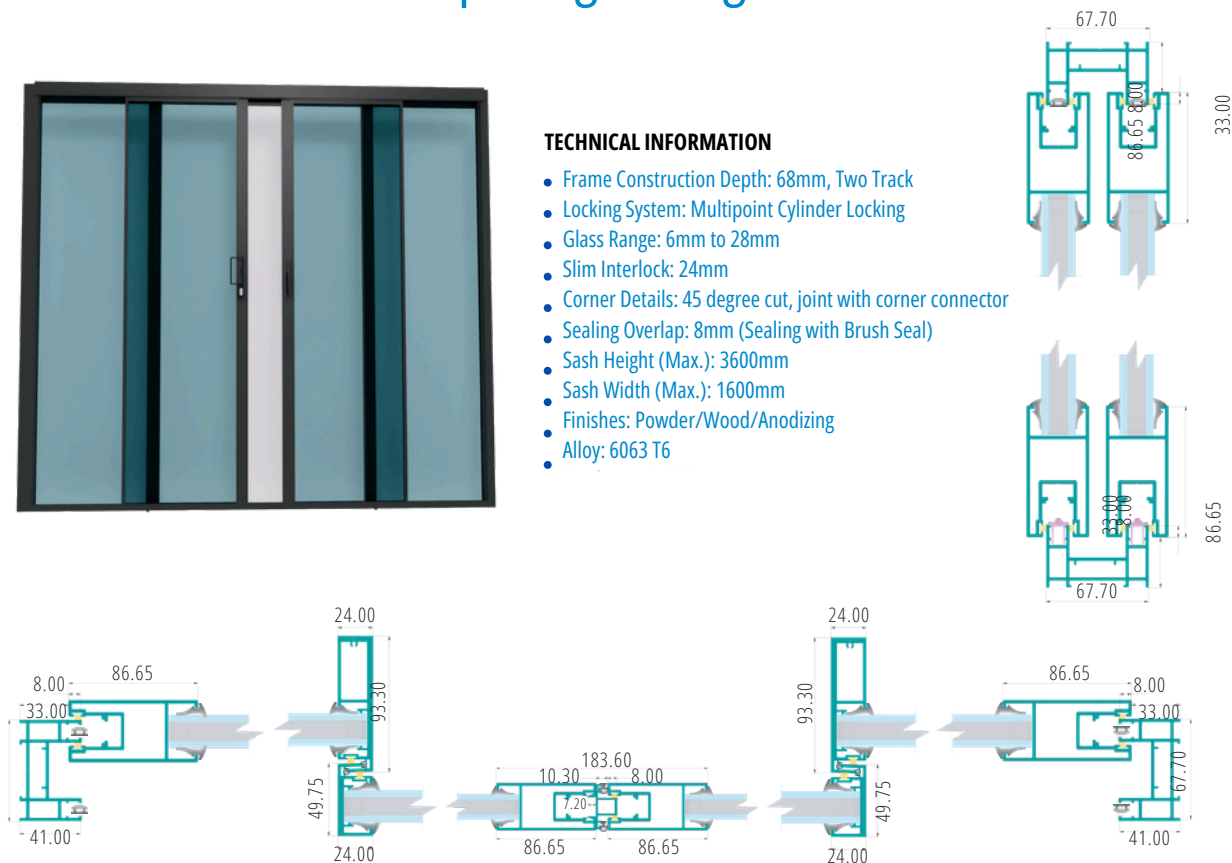

## Two Track With Center Fixed Sliding Door



### TECHNICAL INFORMATION

- Frame Construction Depth: 120mm, Three Track
- Locking System: Multipoint Cylinder Locking
- Glass Range: 6mm to 28mm
- Slim Interlock: 24mm
- Corner Details: 45 degree cut, joint with corner connector
- Sealing Overlap: 8mm (Sealing with Brush Seal)
- Sash Height (Max.): 3600mm
- Sash Width (Max.): 1600mm
- Finishes: Powder/Wood/Anodizing
- Alloy: 6063 T6

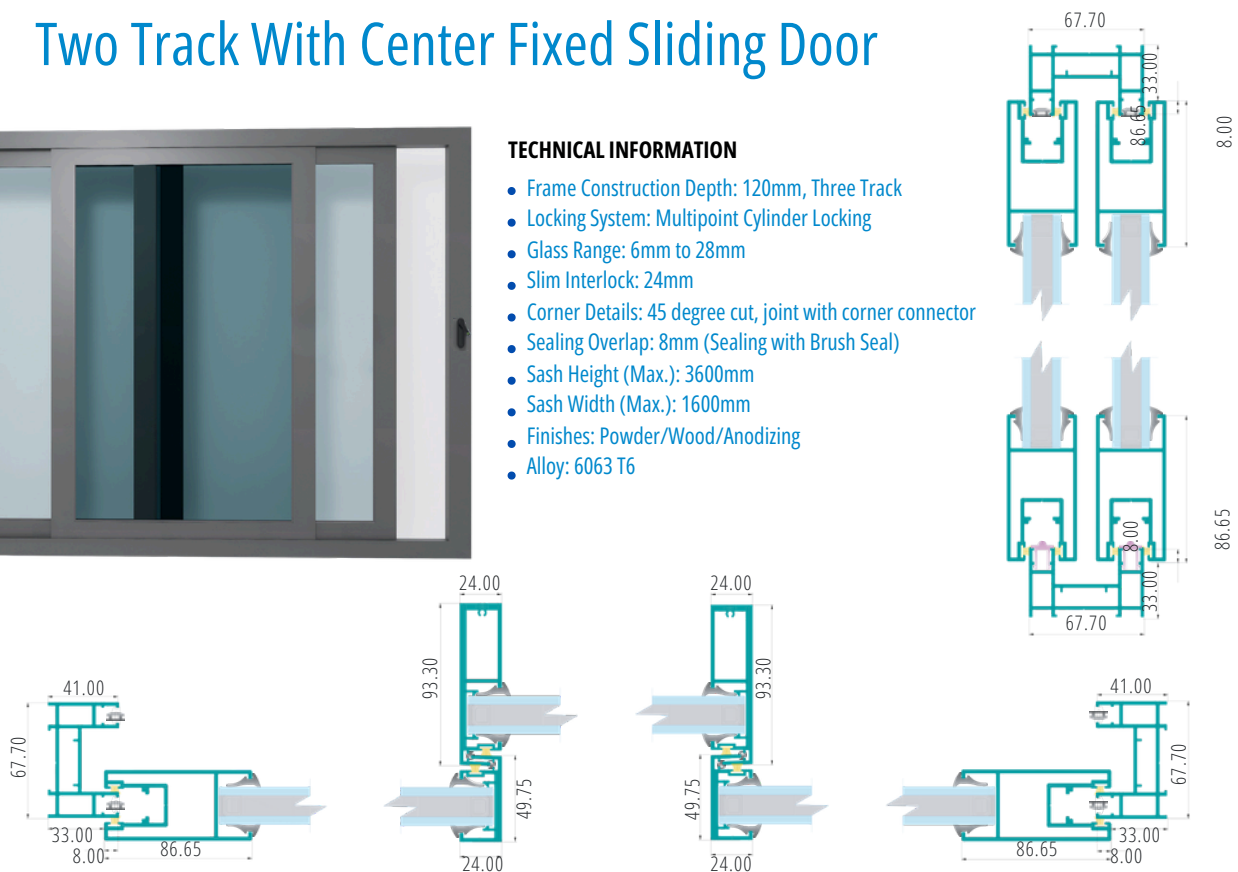

# ULTRA SLIM SERIES



## TECHNICAL INFORMATION

- Frame Construction Depth: 202.49mm, Two Track
- Locking System: Multipoint Cylinder Locking
- Glass Range: 6mm to 32mm
- Frame Corner Details: 90 degree cut, joint with screw
- Sash Corner Details: 45 degree cut, joint with corner connector
- Sealing: (Sealing with Gasket Seal)
- Sash Height (Max.): 3660mm
- Sash Width (Max.): 3660mm
- Weight (Max.): 600kg.
- Finishes: Powder/Wood/Anodizing
- Alloy: 6063 T6

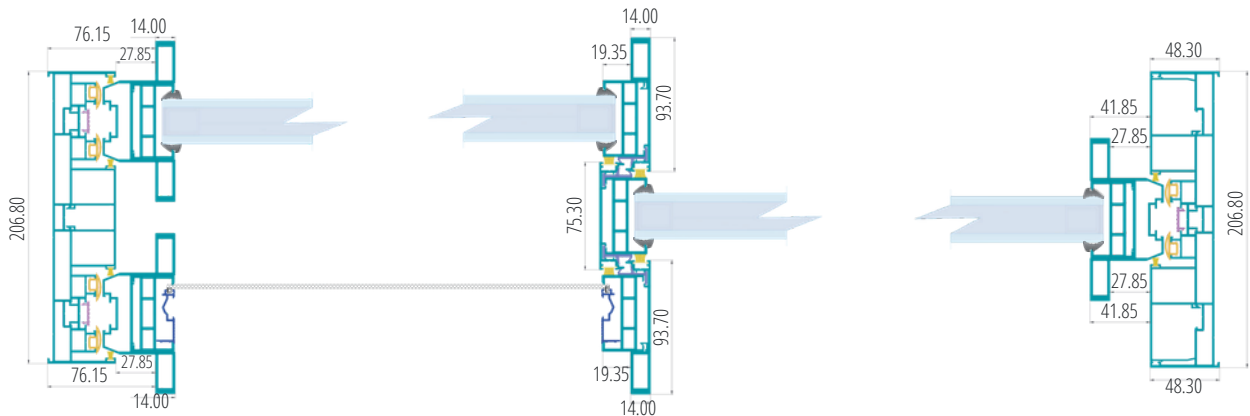
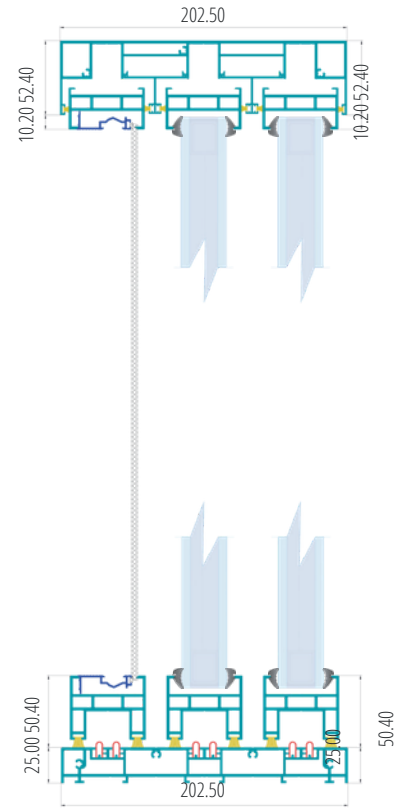

# Aluminium windows/doors

Sliding door design offers flexibility, where one panel can move while the other stays static. You could also have both panels of the door slide independent of each other. These sliding doors offer wide, uninterrupted views and save space as they won't encroach on your balcony or interiors of a home the sliding door move on 2 or 3 tracks

## Features & Benefits

Versatile and durable

Precision rollers ensure smooth movement Option to add

mesh Highly robust and durable Built to withstand wind load

pressure of upto 2.5 kpa

Eco-friendly

Height Upto 15 ft High resale value

Almost completely maintenance free

Branded glass & hardware

Customization in terms of size, glass and colour

**Application:** Residential and Commercial

**Glass Configuration:** 5mm Single glass to 24mm DGU glass

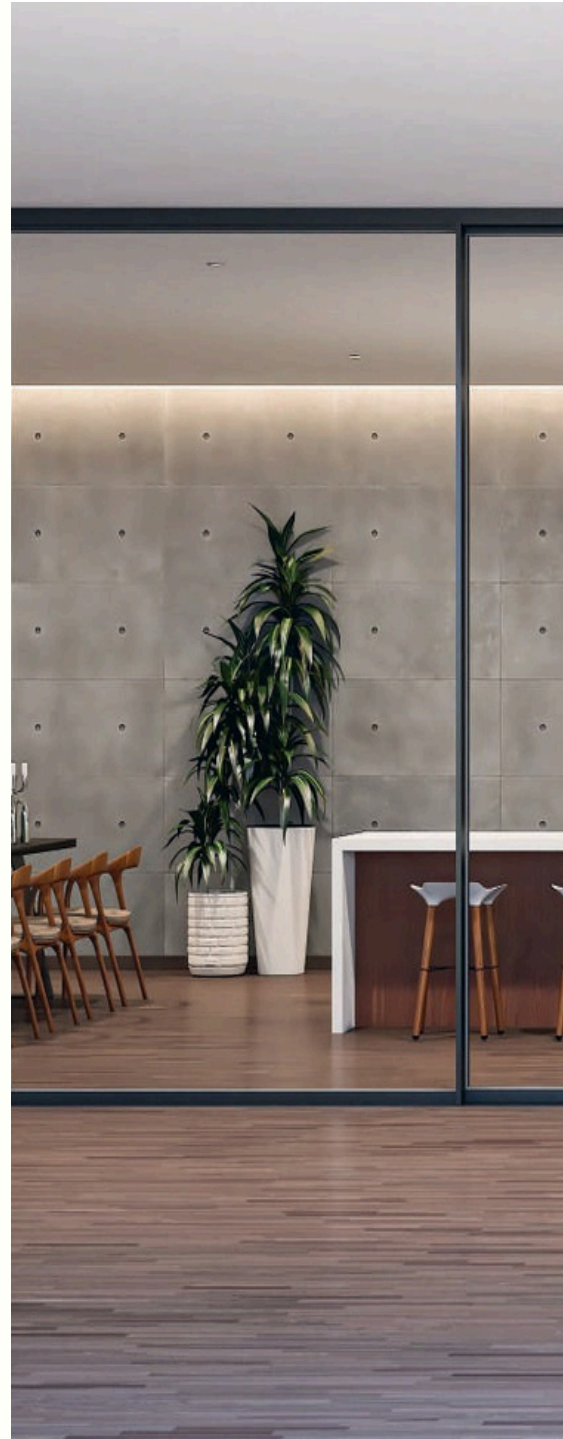
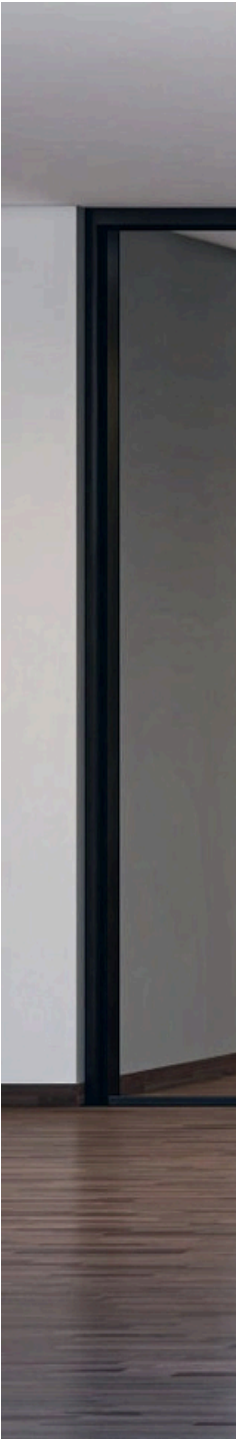
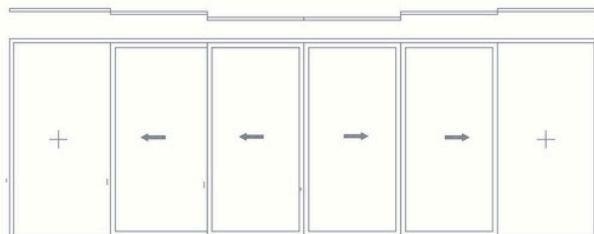
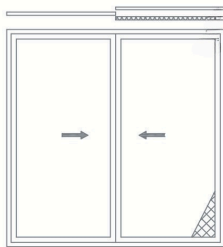



## Sleek Casement Series

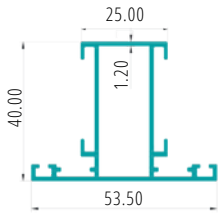

MULLION  
Wt./R.Mtr. : 0.710 kg  
PART CODE:62132

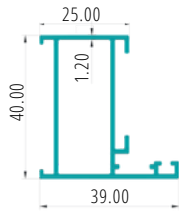

WINDOW FRAME  
Wt./R.Mtr. : 0.574 kg  
PART CODE:62133

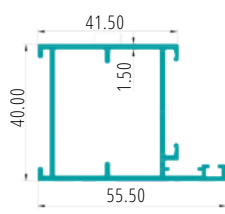

DOOR FRAME  
Wt./R.Mtr. : 0.902 kg  
PART CODE:62334

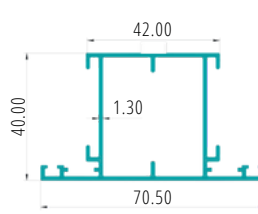

DOOR O/W SHUTTER  
Wt./R.Mtr. : 0.902 kg  
PART CODE:62190

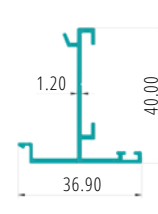

INVERSION  
Wt./R.Mtr. : 0.410 kg  
PART CODE:27083

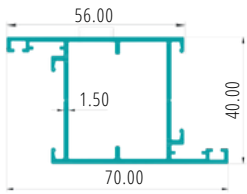

DOOR I/W SHUTTER  
Wt./R.Mtr. : 1.011 kg  
PART CODE:62333

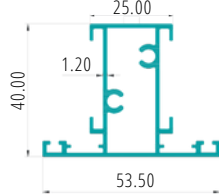

MULLION  
Wt./R.Mtr. : 0.792 kg  
PART CODE:27084

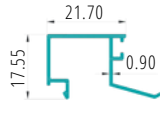

SGU BEADING  
Wt./R.Mtr. : 0.191 kg  
PART CODE:62136

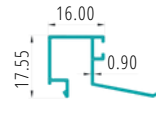

LAMINATED BEADING  
Wt./R.Mtr. : 0.204 kg  
PART CODE:27085

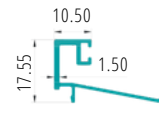

18 DGU BEADING  
Wt./R.Mtr. : 0.245 kg  
PART CODE:27093

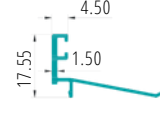

24 DGU BEADING  
Wt./R.Mtr. : 0.177 kg  
PART CODE:27086

## Sleek Sliding Series

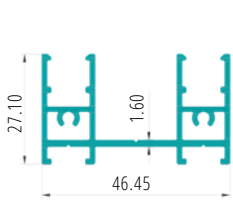

TWO TRACK  
Wt./R.Mtr. : 0.819 kg  
PART CODE:27069

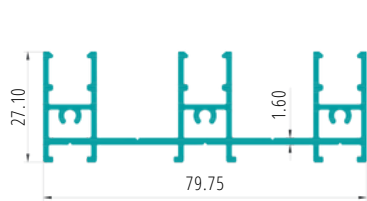

THREE TRACK  
Wt./R.Mtr. : 1.229 kg  
PART CODE:27070

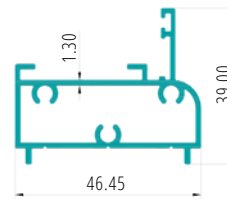

TWO TRACK FIX  
Wt./R.Mtr. : 0.737 kg  
PART CODE:27095

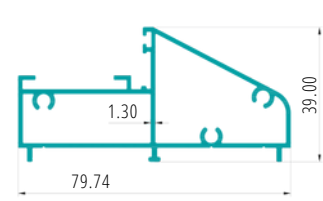

THREE TRACK FIX FRAME  
Wt./R.Mtr. : 1.092 kg  
PART CODE:27094

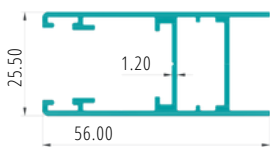

DGU GLASS SHUTTER  
Wt./R.Mtr. : 0.737 kg  
PART CODE:27071

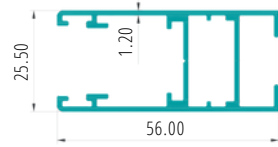

SGU GLASS SHUTTER  
Wt./R.Mtr. : 0.765 kg  
PART CODE:27075

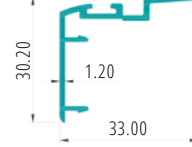

INTERLOCK  
Wt./R.Mtr. : 0.300 kg  
PART CODE:27072

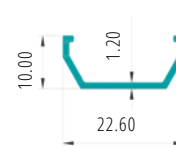

LAMINATED GLASS REDUCER  
Wt./R.Mtr. : 0.164 kg  
PART CODE:27114

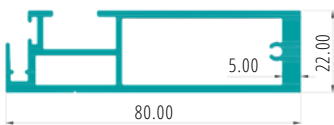

SLIM SGU INTERLOCK  
(RECTANGLE HURRICANE BAR)  
Wt./R.Mtr. : 1.448 kg  
PART CODE:27148

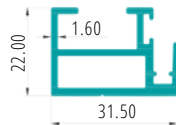

SLIM SGU INTERLOCK  
Wt./R.Mtr. : 0.628 kg  
PART CODE:27149

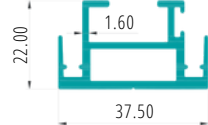

SLIM SGU DOUBLE INTERLOCK  
Wt./R.Mtr. : 0.738 kg  
PART CODE:27150

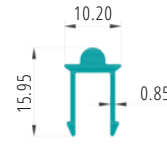

GUIDE RAIL  
Wt./R.Mtr. : 0.136 kg  
PART CODE:27073

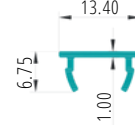

MESH BEADING  
Wt./R.Mtr. : 0.081 kg  
PART CODE:27074

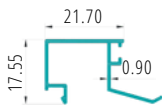

SGU BEADING  
Wt./R.Mtr. : 0.191 kg  
PART CODE:62136

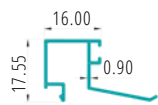

LAMINATED BEADING  
Wt./R.Mtr. : 0.204 kg  
PART CODE:27085



18 DGU BEADING  
Wt./R.Mtr. : 0.245 kg  
PART CODE:27093

# Premium Casement Series

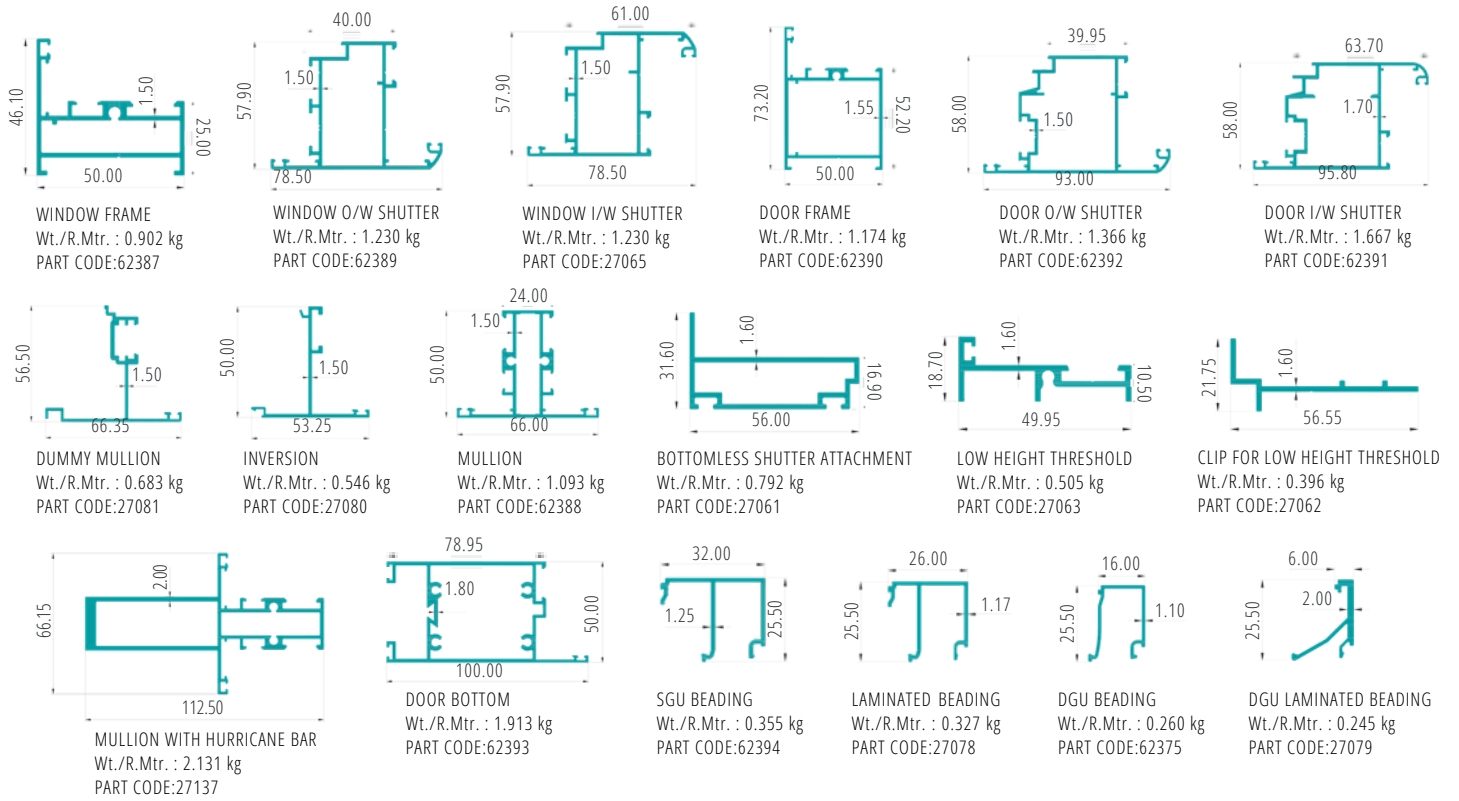

# Premium Sliding Series

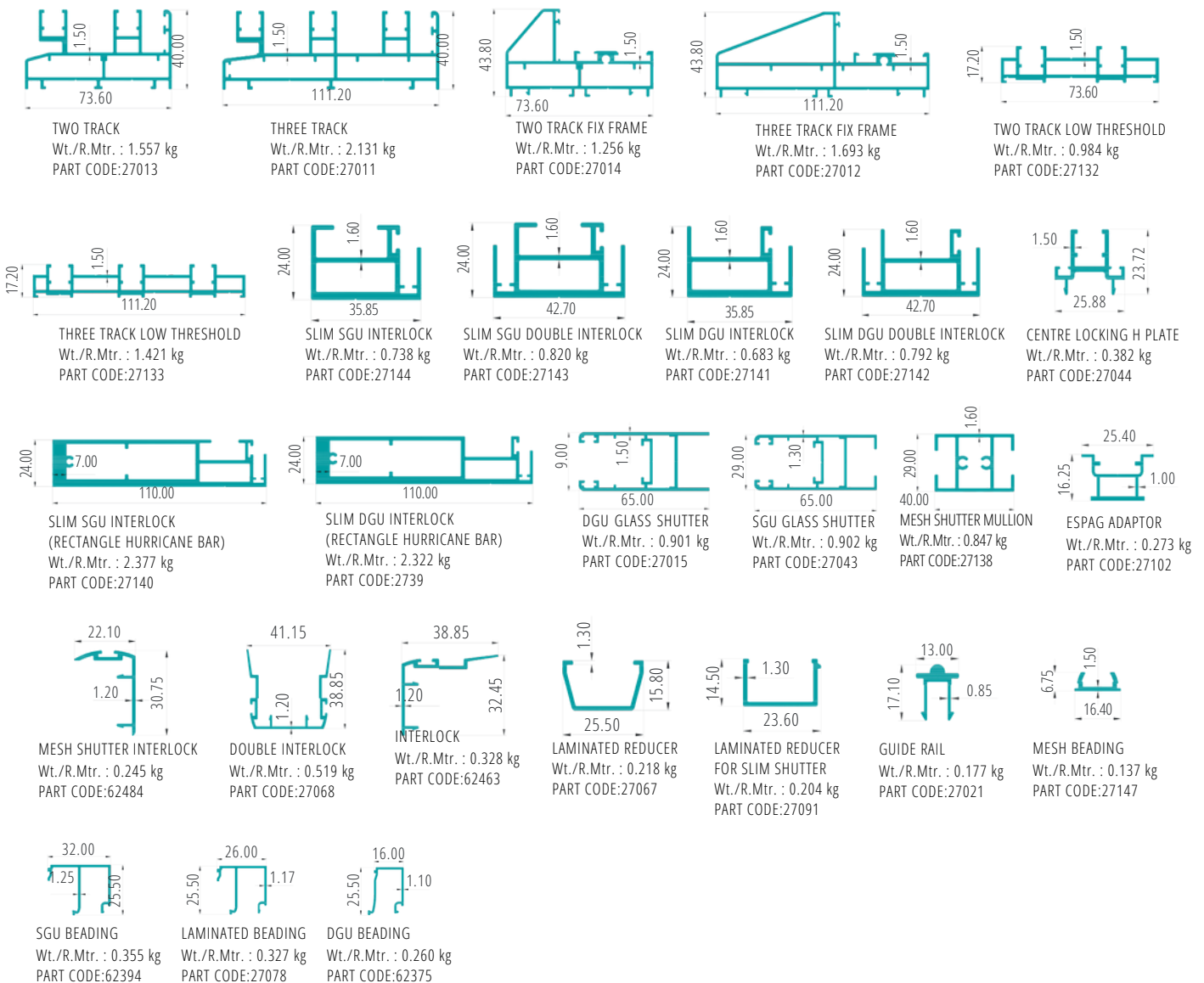

# Premium Villa Series

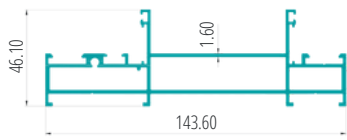

**FRAME**  
Wt./R.Mtr. : 2.131 kg  
PART CODE:27152

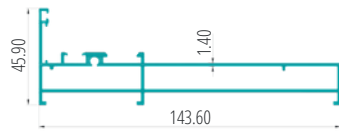

**SIDE FIX FRAME**  
Wt./R.Mtr. : 1.694 kg  
PART CODE:27153

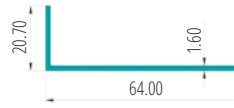

**CENTRE FRAME**  
Wt./R.Mtr. : 0.492 kg  
PART CODE:27154

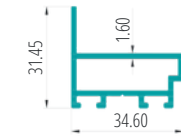

**BOTTOMLESS SHUTTER ATTACHMENT**  
Wt./R.Mtr. : 0.601 kg  
PART CODE:27155

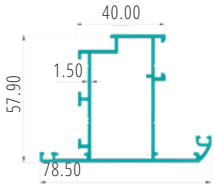

**WINDOW O/W SHUTTER**  
Wt./R.Mtr. : 1.230 kg  
PART CODE:62389

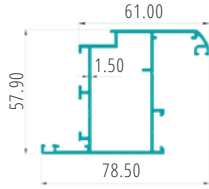

**WINDOW I/W SHUTTER**  
Wt./R.Mtr. : 1.230 kg  
PART CODE:27065

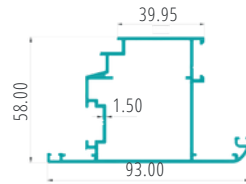

**DOOR O/W SHUTTER**  
Wt./R.Mtr. : 1.366 kg  
PART CODE:62392

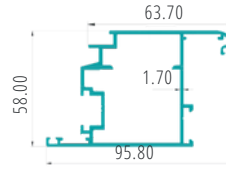

**DOOR I/W SHUTTER**  
Wt./R.Mtr. : 1.667 kg  
PART CODE:62391

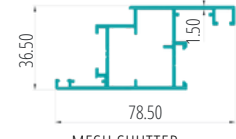

**MESH SHUTTER**  
Wt./R.Mtr. : 1.038 kg  
PART CODE:27156

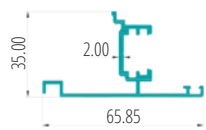

**MESH SHUTTER DUMMY MULLION**  
Wt./R.Mtr. : 0.683 kg  
PART CODE:27157

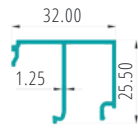

**SGU BEADING**  
Wt./R.Mtr. : 0.355 kg  
PART CODE:62394



**LAMINATED BEADING**  
Wt./R.Mtr. : 0.327 kg  
PART CODE:27078



**DGU BEADING**  
Wt./R.Mtr. : 0.260 kg  
PART CODE:62375

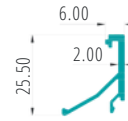

**DGU LAMINATED BEADING**  
Wt./R.Mtr. : 0.245 kg  
PART CODE:27079

# Ultra Slim Series

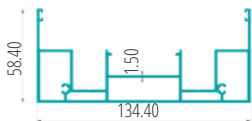

**TWO TRACK TOP**  
Wt./R.Mtr. : 2.846 kg  
PART CODE:27130

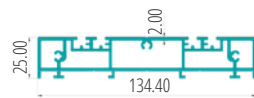

**TWO TRACK BOTTOM**  
Wt./R.Mtr. : 2.650 kg  
PART CODE:27131

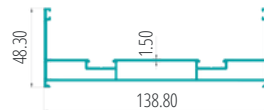

**TWO TRACK SIDE**  
Wt./R.Mtr. : 1.913 kg  
PART CODE:27129

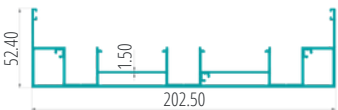

**THREE TRACK TOP**  
Wt./R.Mtr. : 3.333 kg  
PART CODE:27109

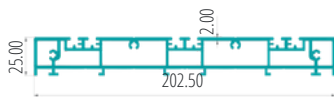

**THREE TRACK BOTTOM**  
Wt./R.Mtr. : 3.770 kg  
PART CODE:27116

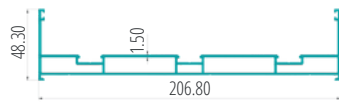

**THREE TRACK SIDE**  
Wt./R.Mtr. : 2.596 kg  
PART CODE:27115

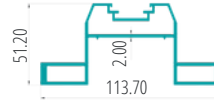

**SHUTTER LOCK SIDE**  
Wt./R.Mtr. : 2.049 kg  
PART CODE:27117



**INTERLOCK WITH HURRICANE BAR**  
Wt./R.Mtr. : 1.366 kg  
PART CODE:27118



**CENTRE INTERLOCK**  
Wt./R.Mtr. : 0.683 kg  
PART CODE:27119

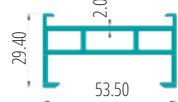

**SHUTTER**  
Wt./R.Mtr. : 1.038 kg  
PART CODE:27121

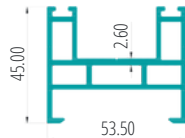

**SHUTTER BOTTOM**  
Wt./R.Mtr. : 0.901 kg  
PART CODE:27120

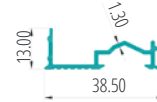

**MESH BEADING**  
Wt./R.Mtr. : 0.273 kg  
PART CODE:27122



**SGU GLASS REDUCER**  
Wt./R.Mtr. : 0.328 kg  
PART CODE:27123

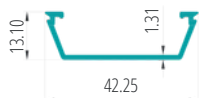

**DGU GLASS REDUCER**  
Wt./R.Mtr. : 0.273 kg  
PART CODE:27124



**SIDE TRACK DIVIDE**  
Wt./R.Mtr. : 0.601 kg  
PART CODE:27125

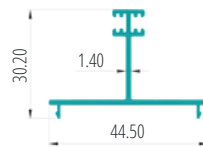

**TOP TRACK DIVIDE**  
Wt./R.Mtr. : 0.383 kg  
PART CODE:27126

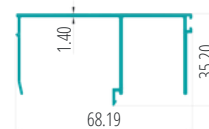

**SIDE TRACK COVER**  
Wt./R.Mtr. : 0.656 kg  
PART CODE:27127

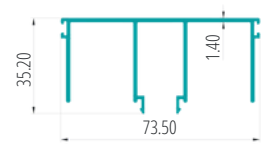

**SIDE TRACK CENTRE COVER**  
Wt./R.Mtr. : 0.874 kg  
PART CODE:27128

# Sky Casement Series

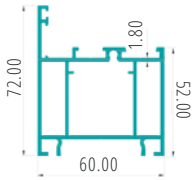

DOOR FRAME  
Wt./R.Mtr. : 1.857 kg  
PART CODE:27047

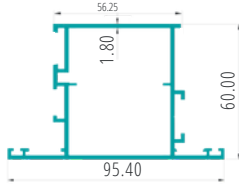

DOOR O/W SHUTTER  
Wt./R.Mtr. : 1.639 kg  
PART CODE:27048

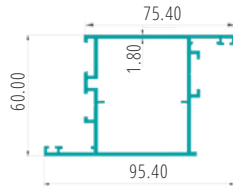

DOOR I/W SHUTTER  
Wt./R.Mtr. : 1.666 kg  
PART CODE:27049

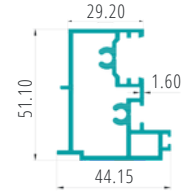

DUMMY MULLION  
Wt./R.Mtr. : 1.147 kg  
PART CODE:27050

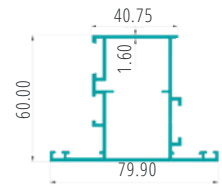

WINDOW O/W SHUTTER  
Wt./R.Mtr. : 1.366 kg  
PART CODE:27052

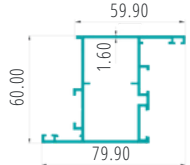

WINDOW I/W SHUTTER  
Wt./R.Mtr. : 1.366 kg  
PART CODE:27053

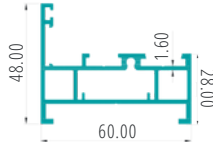

WINDOW FRAME  
Wt./R.Mtr. : 1.448 kg  
PART CODE:27055

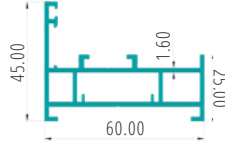

TOP HUNG FRAME  
Wt./R.Mtr. : 1.147 kg  
PART CODE:27057

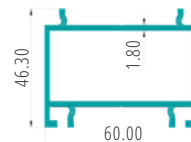

EXTENSION FRAME  
Wt./R.Mtr. : 1.311 kg  
PART CODE:27051

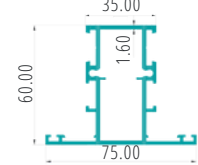

MULLION  
Wt./R.Mtr. : 1.393 kg  
PART CODE:27056

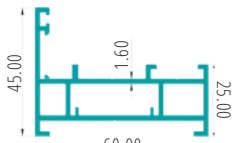

PARALLEL WINDOW FRAME  
Wt./R.Mtr. : 1.203 kg  
PART CODE:27103

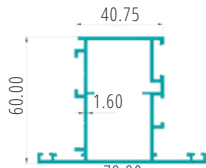

PARALLEL WINDOW O/W SHUTTER  
Wt./R.Mtr. : 1.393 kg  
PART CODE:27104

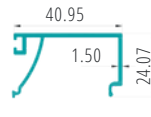

SGU BEADING  
Wt./R.Mtr. : 0.437 kg  
PART CODE:27059

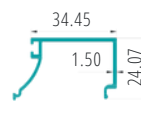

LAMINATED BEADING  
Wt./R.Mtr. : 0.382 kg  
PART CODE:27060

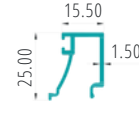

DGU LAMINATED  
32mm BEADING  
Wt./R.Mtr. : 0.300 kg  
PART CODE:27105

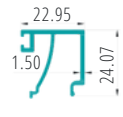

DGU BEADING  
Wt./R.Mtr. : 0.355 kg  
PART CODE:27058

# Sky Sliding Series

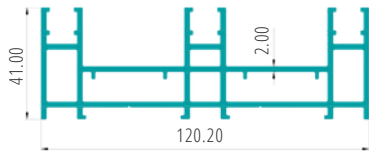

THREE TRACK  
Wt./R.Mtr. : 2.814 kg  
PART CODE:27025

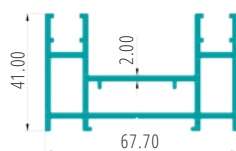

TWO TRACK  
Wt./R.Mtr. : 1.693 kg  
PART CODE:27046

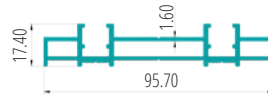

TWO TRACK LOW THRESHOLD  
Wt./R.Mtr. : 1.257 kg  
PART CODE:27134



THREE TRACK LOW THRESHOLD  
Wt./R.Mtr. : 1.885 kg  
PART CODE:27135

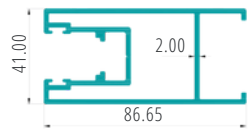

GLASS SHUTTER  
Wt./R.Mtr. : 1.995 kg  
PART CODE:27026

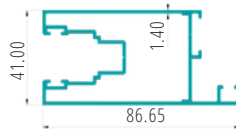

MESH SHUTTER  
Wt./R.Mtr. : 1.366 kg  
PART CODE:27027



MESH SHUTTER MULLION  
Wt./R.Mtr. : 1.147 kg  
PART CODE:27045

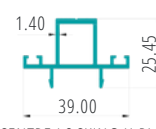

CENTRE LOCKING H PLATE  
Wt./R.Mtr. : 0.491 kg  
PART CODE:27031

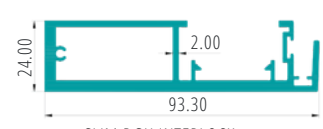

SLIM DGU INTERLOCK  
(RECTANGLE HURRICANE BAR)  
Wt./R.Mtr. : 1.885 kg  
PART CODE:27096

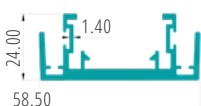

SLIM DGU DOUBLE INTERLOCK  
Wt./R.Mtr. : 1.120 kg  
PART CODE:27097

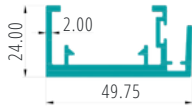

SLIM DGU INTERLOCK  
Wt./R.Mtr. : 0.983 kg  
PART CODE:27098



SLIM MESH SHUTTER  
Wt./R.Mtr. : 0.765 kg  
PART CODE:27099

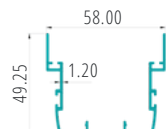

DOUBLE INTERLOCK  
Wt./R.Mtr. : 0.710 kg  
PART CODE:27030

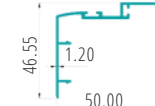

INTERLOCK  
Wt./R.Mtr. : 0.437 kg  
PART CODE:27029

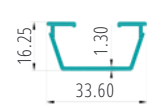

SGU REDUCER FOR  
SLIM SHUTTER  
Wt./R.Mtr. : 0.300 kg  
PART CODE:27100

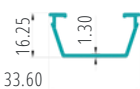

LAMINATED REDUCER FOR  
SLIM SHUTTER  
Wt./R.Mtr. : 0.273 kg  
PART CODE:27101



LAMINATED REDUCER  
Wt./R.Mtr. : 0.327 kg  
PART CODE:27066

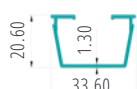

SGU REDUCER  
Wt./R.Mtr. : 0.327 kg  
PART CODE:27032

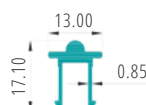

GUIDE RAIL  
Wt./R.Mtr. : 0.177 kg  
PART CODE:27021



MESH BEADING  
Wt./R.Mtr. : 0.300 kg  
PART CODE:27028

# Universal Profiles

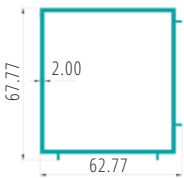

**BAY POLE**  
Wt./R.Mtr. : 1.475 kg  
PART CODE:27054

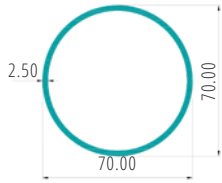

**ROUND BAY POLE**  
Wt./R.Mtr. : 1.557 kg  
PART CODE:27106



**ROUND BAY POLE CONNECTOR**  
Wt./R.Mtr. : 0.874 kg  
PART CODE:27107

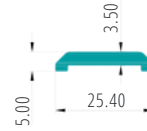

**GEORGIAN BAR**  
Wt./R.Mtr. : 0.273 kg  
PART CODE:27082



**PREMIUM SLIDING HURRICANE  
BAR REINFORCEMENT**  
Wt./R.Mtr. : 0.820 kg  
PART CODE:27108

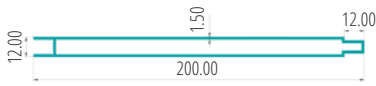

**DOOR PANNEL**  
Wt./R.Mtr. : 1.802 kg  
PART CODE:27158

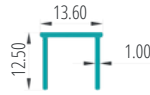

**CASEMENT DOOR COVER PROFILE**  
Wt./R.Mtr. : 0.123 kg  
PART CODE:27136

# Slim Series



Wt./R.Mtr. : 0.628 kg  
PART CODE:62455

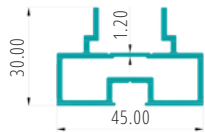

Wt./R.Mtr. : 0.792 kg  
PART CODE:62456



**FIX PROFILE**  
Wt./R.Mtr. : 0.456 kg  
PART CODE:62457

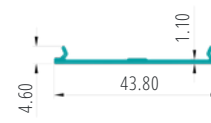

**COVER PROFILE**  
Wt./R.Mtr. : 0.178 kg  
PART CODE:62458

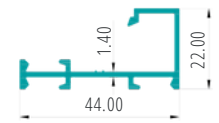

**MALE FIX PROFILE**  
Wt./R.Mtr. : 0.410 kg  
PART CODE:62459

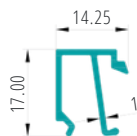

**FEMALE FIX PROFILE**  
Wt./R.Mtr. : 0.191 kg  
PART CODE:62460

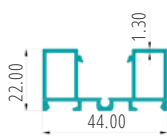

**DOOR FIX**  
Wt./R.Mtr. : 0.656 kg  
PART CODE:62464

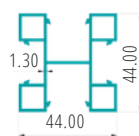

**4 WAY PROFILE**  
Wt./R.Mtr. : 0.984 kg  
PART CODE:62465

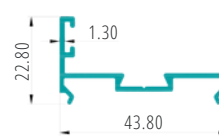

**DOOR JAM**  
Wt./R.Mtr. : 0.355 kg  
PART CODE:62466

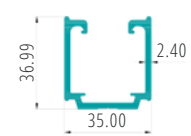

Wt./R.Mtr. : 0.874 kg  
PART CODE:62522



Wt./R.Mtr. : 0.410 kg  
PART CODE:62523

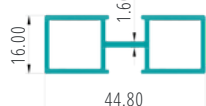

Wt./R.Mtr. : 0.546 kg  
PART CODE:62524



Wt./R.Mtr. : 0.246 kg  
PART CODE:62525

# Glazing

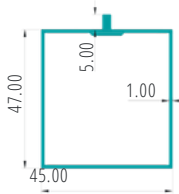

Wt./R.Mtr. : 0.628 kg  
PART CODE:62126

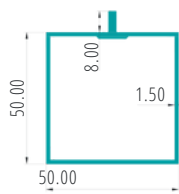

Wt./R.Mtr. : 0.956 kg  
PART CODE:62127

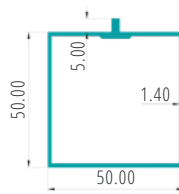

Wt./R.Mtr. : 0.902 kg  
PART CODE:62137

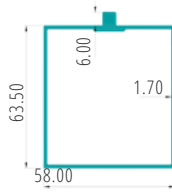

Wt./R.Mtr. : 1.284 kg  
PART CODE:62215

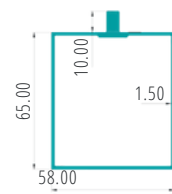

Wt./R.Mtr. : 1.284 kg  
PART CODE:62227



PRESSURE PLATE  
Wt./R.Mtr. : 0.492 kg  
PART CODE:62254

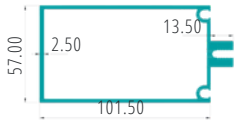

Wt./R.Mtr. : 2.322 kg  
PART CODE:62256



CAP  
Wt./R.Mtr. : 0.383 kg  
PART CODE:62255

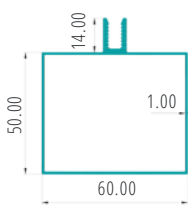

Wt./R.Mtr. : 0.847 kg  
PART CODE:62175

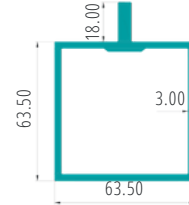

Wt./R.Mtr. : 2.459 kg  
PART CODE:62331

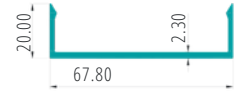

Wt./R.Mtr. : 0.628 kg  
PART CODE:62521



Wt./R.Mtr. : 0.902 kg  
PART CODE:62520



Wt./R.Mtr. : 4.235 kg  
PART CODE:62519



Wt./R.Mtr. : 2.787 kg  
PART CODE:62544



Wt./R.Mtr. : 1.995 kg  
PART CODE:62545

# Kitchen Profiles



Wt./R.Mtr. : 0.478 kg  
PART CODE:62264

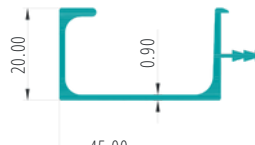

Wt./R.Mtr. : 0.328 kg  
PART CODE:62322

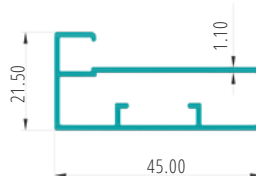

Wt./R.Mtr. : 0.464 kg  
PART CODE:62461



Wt./R.Mtr. : 0.628 kg  
PART CODE:62462

# uPVC Guiderails

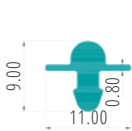

Wt./R.Mtr. : 0.109 kg  
PART CODE:45110

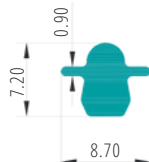

Wt./R.Mtr. : 0.096 kg  
PART CODE:62271

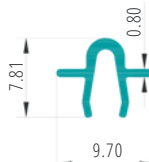

Wt./R.Mtr. : 0.060 kg  
PART CODE:62272

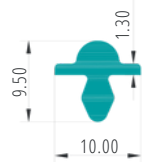

Wt./R.Mtr. : 0.112 kg  
PART CODE:62318

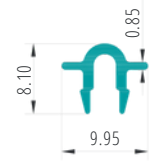

Wt./R.Mtr. : 0.068 kg  
PART CODE:62319

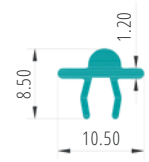

Wt./R.Mtr. : 0.082 kg  
PART CODE:62320

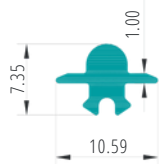

Wt./R.Mtr. : 0.093 kg  
PART CODE:62321

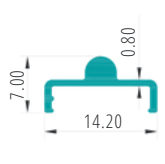

Wt./R.Mtr. : 0.082 kg  
PART CODE:62386

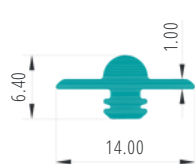

Wt./R.Mtr. : 0.096 kg  
PART CODE:62405

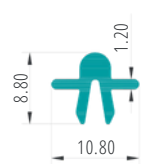

Wt./R.Mtr. : 0.096 kg  
PART CODE:62406

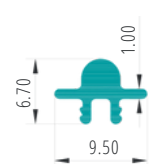

Wt./R.Mtr. : 0.077 kg  
PART CODE:62416

# Railings

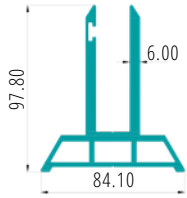

Wt./R.Mtr. : 4.235kg  
PART CODE:62533

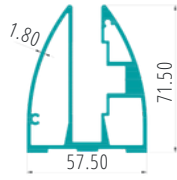

Wt./R.Mtr. : 2.322kg  
PART CODE:27110

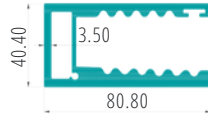

Wt./R.Mtr. : 3.197kg  
PART CODE:27111

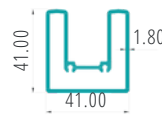

Wt./R.Mtr. : 1.120kg  
PART CODE:27112

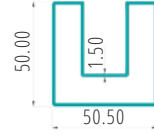

Wt./R.Mtr. : 1.148kg  
PART CODE:27113

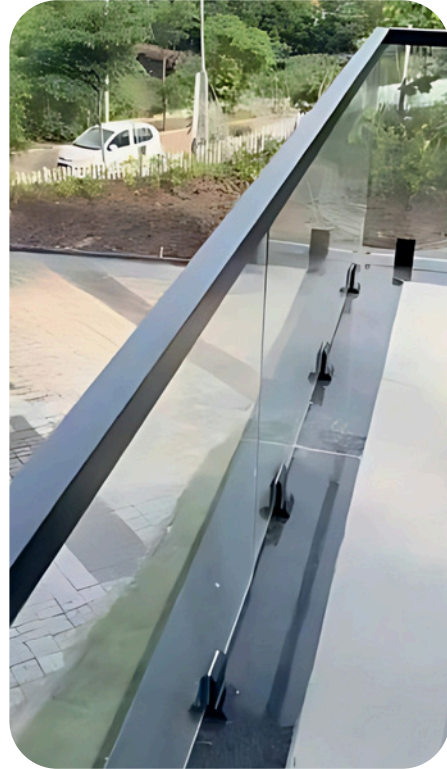

# Handles



BH-9014



BH-9018



BH-9017



BH-9020



BH-9019



BH-9022



BH-9023



BH-9033



BH-9072



BH-9074



BH-9025



BH-9024

# Gaskets



BG-7001



BG-7002



BG-7004



BG-7003



BG-7005



BG-7006



BG-7007



BG-7008



BG-7009



BG-7010

# Mesh

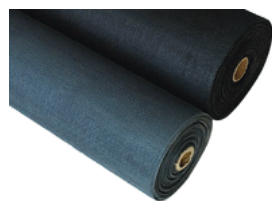

BM-6001



BM-6002

# Hardwares



BH-9003

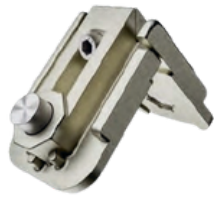

BH-9004



BH-9006



BH-9008



BH-9009



BH-9010



BH-9011



BH-9012



BH-9037



BH-9038



BH-9039



BH-9040



BH-9041



BH-9042



BH-9046



BH-9055



BH-9056



BH-9060



BH-9067



BH-9065

# Accessories



BA-8004



BA-8005



BA-8006



BA-8007

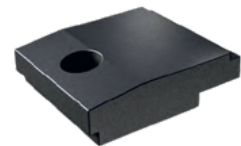

BA-8009



BA-8008



BA-8011



BS-5001



BA-8002



# Why Aluminium Windows?

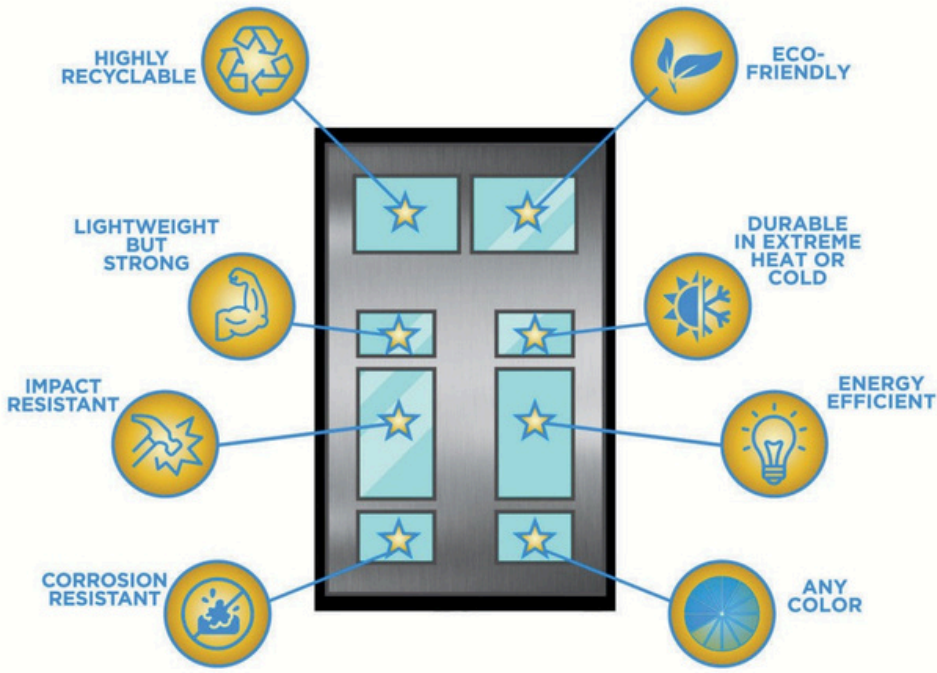

# Finishes

A large variety of colors and finishes accentuating the look of your house with more than 8 RAL finishes in vibrant colors and panels of different patterns like gloss and matte finishes, pastel shades & metallic colors and also wood grain finish, you have a classy pick for your windows or doors.

## POWDER COATING



**SP338N** Schueco Grey  
Fine Texture



**SW31BN** 2900 MT Grey  
Fine Texture

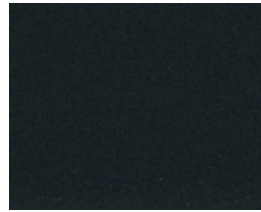

**SW324N** Noir 2200 Sable  
Fine Texture



**SW30BN** 2500 MT Grey  
Fine Texture

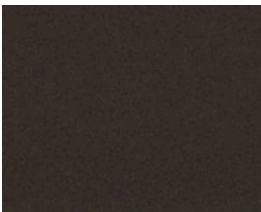

**SW28BN** Anodic Bronze III  
Matt

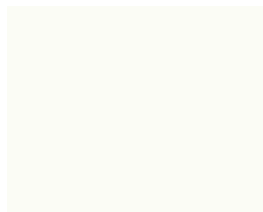

**SC18AN** RAL 9016  
Satin

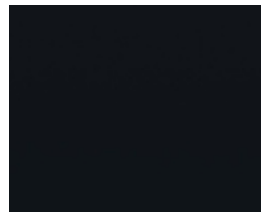

**SN25AN** RAL 9005  
Matt



**SDA53N** Champagne  
Matt

## SUBLIMATION



**Pine Tree**



**Kentucky Cherry**

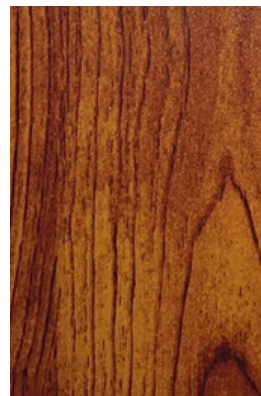

**Atlantic Beige**

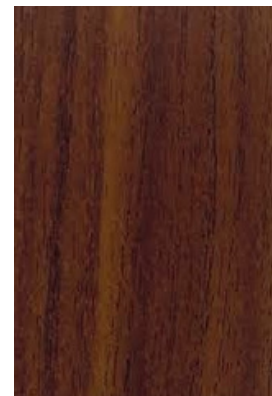

**Walnut**



# Features



**Sound resistant interlock with double sealing**  
 High levels of sound insulation. The gaskets ensure shutter banging noise is suppressed and wool pile sealing makes it dust/wind resistant.



**Designed for torrential weather conditions**  
 With extra strengthening and reinforced handle and interlock sections.



**Sturdy shutter joinery with plastic inserts**  
 But over lapping joinery and twin screw provides excellent strength. Anti-rattle plastic inserts leave no gaps and voids.



**Sturdy and leak-proof frame joinery**  
**Frame Inserts** eliminates any possibility of gaps and water to seep inside. It's a first developed only by MyWindow.



**Solid aluminium extruded track**  
 The solid Aluminium extruded track makes sure that the shutter weight is held easily without any sagging after usage, at the same time removing the possibility of any dents.

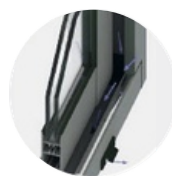

**Gated Drainage**  
 This specially designed water cap acts as one way valve allowing water to drain out and block wind entering the system.



Cost effective



Noise Reduction



Long Lasting &  
Low maintenance



More Colour  
Choice



Built For Extreme  
Weather Conditions



Water  
Tightness



100% Recyclable



Save Energy

## **FRAMES by Riyom Global Solutions**

Email: [contact@riyomglobal.in](mailto:contact@riyomglobal.in)

Mob : +91 9559721155